

# 8'x5' Grill Gazebo Fargo

Owner's Manual  
OUTDOOR PATIO GAZEBO  
MODEL #HFZP01019

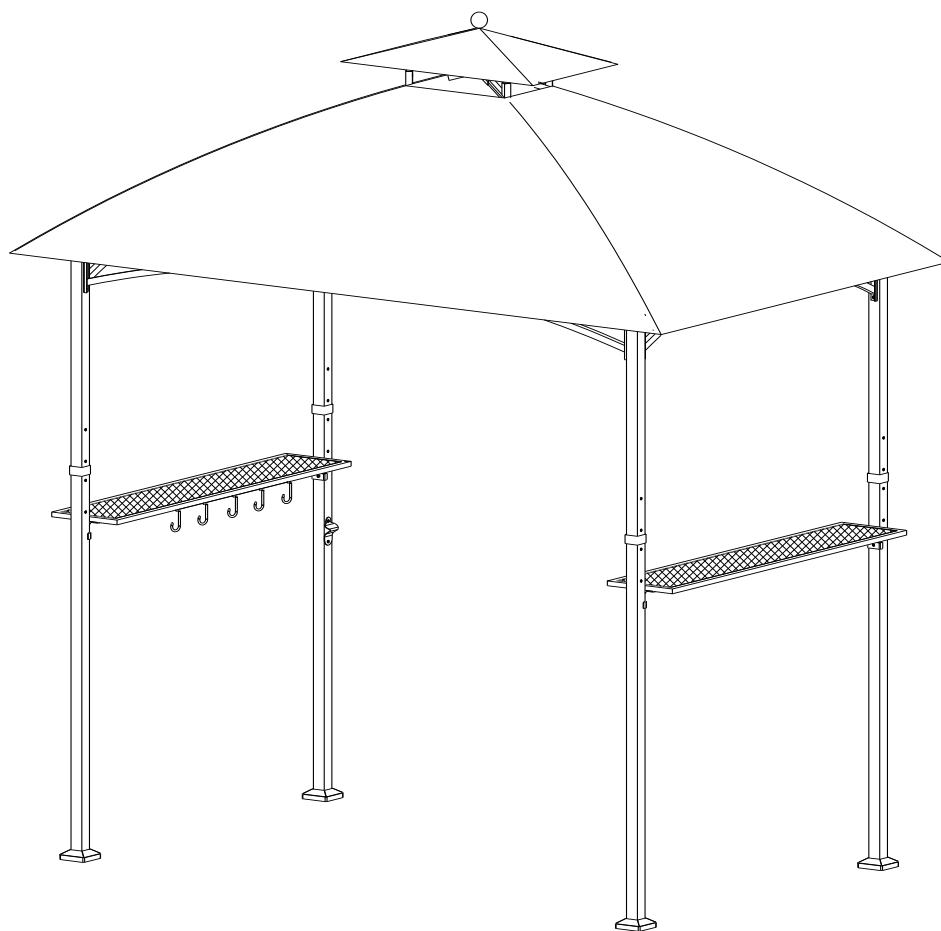

## Assemble Tips

1. Secure the assembly area. Keep children and pets away from the assembly area.
2. It is recommended that two or more adults are involved, to assemble the pergola.
3. Ensure that all connectors & poles are firmly secured in position fully. A unstable gazebo may collapse or damage unpredictably.

## Fire Caution

1. Do not use candles, matches or open flames of any kind in or near.
2. Keep all flame and heat source away from this Tent Fabric. This tent is made with fabric that meets CPAI-84 specifications for flame resistance. It is not fire proof. The fabric will burn if left in continuous contact with any flame source.

## Extremely Weather

1. Do not leave the gazebo assembled when there is a risk of high wind, the top cloth may be blown away and the structure may be damaged.
2. Do not use the gazebo during an electrical storm.
3. Warranty does not cover damage due to extreme weather conditions.





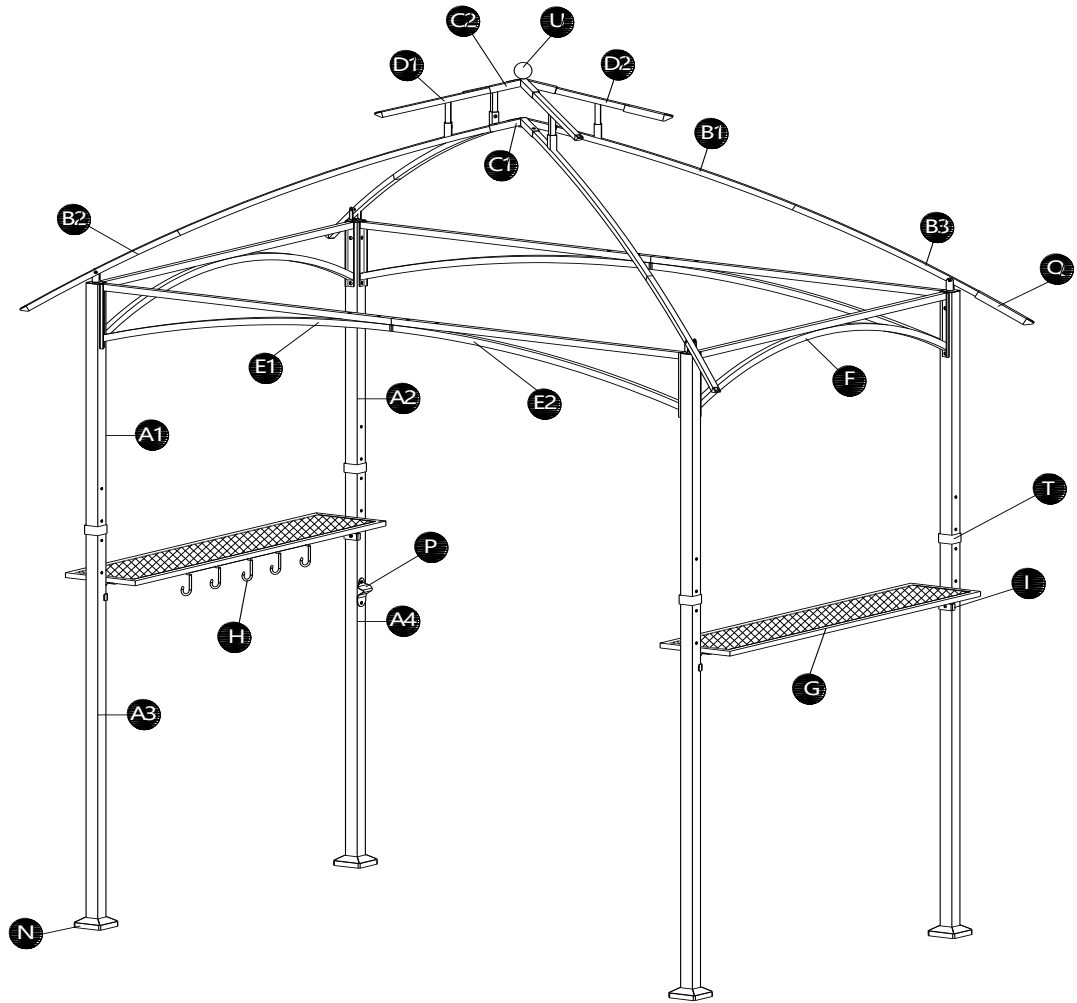

## Contact Us

If you have any comments or suggestions, Please feel free to contact us.



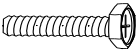

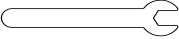
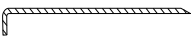





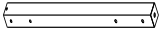
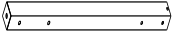
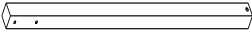

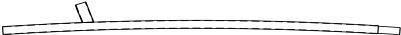
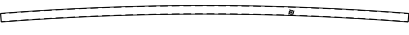
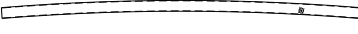
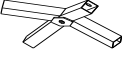
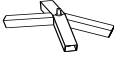
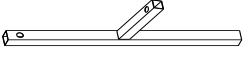
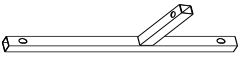

[Service@hofzelt.com](mailto:Service@hofzelt.com)





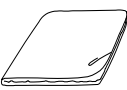



## HARDWARE CONTENTS

No.	DESCRIPTION	Draft	QTY	EXTRA
AA	M6x20 Bolt		88	5
BB	Washer		96	5
CC	M6x35 Bolt		4	1
DD	Nut		4	1
EE	Wrench		1	0
FF	Stake		8	0
GG	M6x15 Bolt		2	0
HH	Plastic Cap		32	2

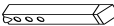
## PACKAGE CONTENTS

No.	DESCRIPTION	Draft	QTY
A1	Upper Post at Left		2
A2	Upper Post at Right		2
A3	Bottom Post		3
A4	Bottom Post with Bottle Opener		1
B1	Up of Big Beam		4
B2	End of Big Beam		3
B3	End of Big Beam with hole for Regulating Tube		1
C1	Big Top Connector		1
C2	Small Top Connector		1
D1	Beam for small top		3
D2	Beam for small top with hole for Regulating Tube		1
E1	Left Long Screen		2
E2	Right Long Screen		2
F	Short Screen		2
G	Shelf		2
H	Hook Rack		1
I	Panel Connector		4
J	Small Canopy		1
K	Big Canopy		1
L	Hook		1
M	U Shape Part For Upper Post		4
N	Stake Cover		4

O	Stake Base		4
P	Bottle Opener		1
Q	Top Regulating Pipe		2
R	Long Screen Middle Connector		2
S	Post Connector		8
T	Plastic Connector		4
U	Decorative Ball		1

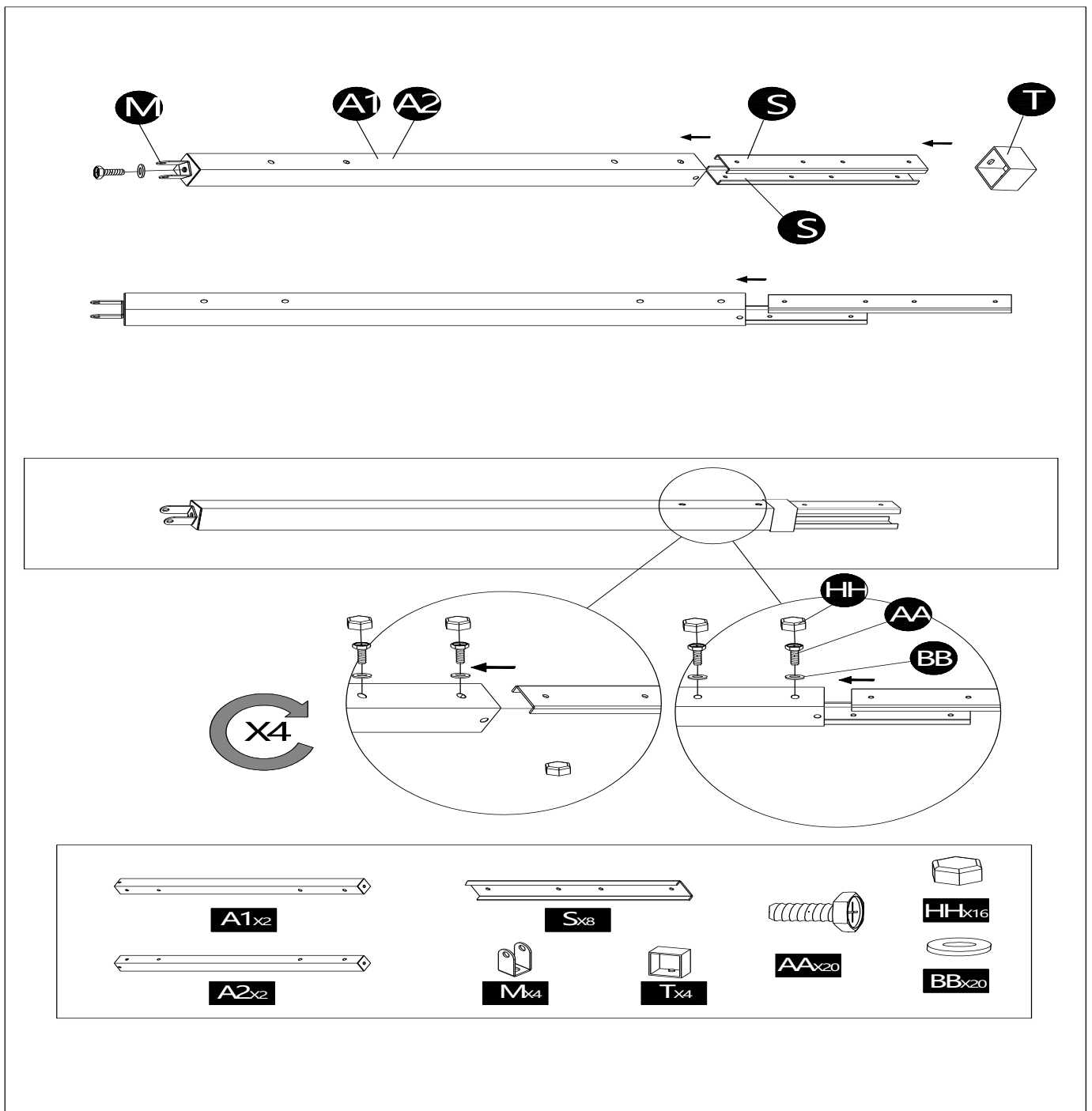

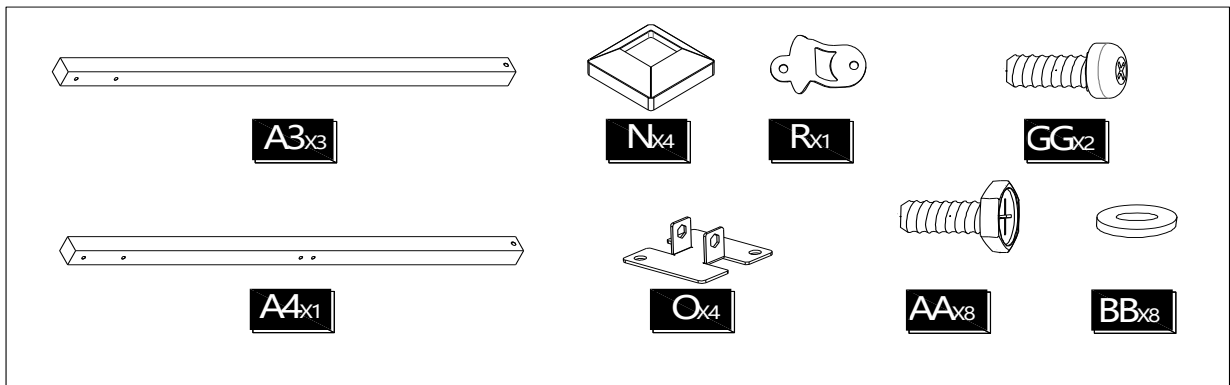
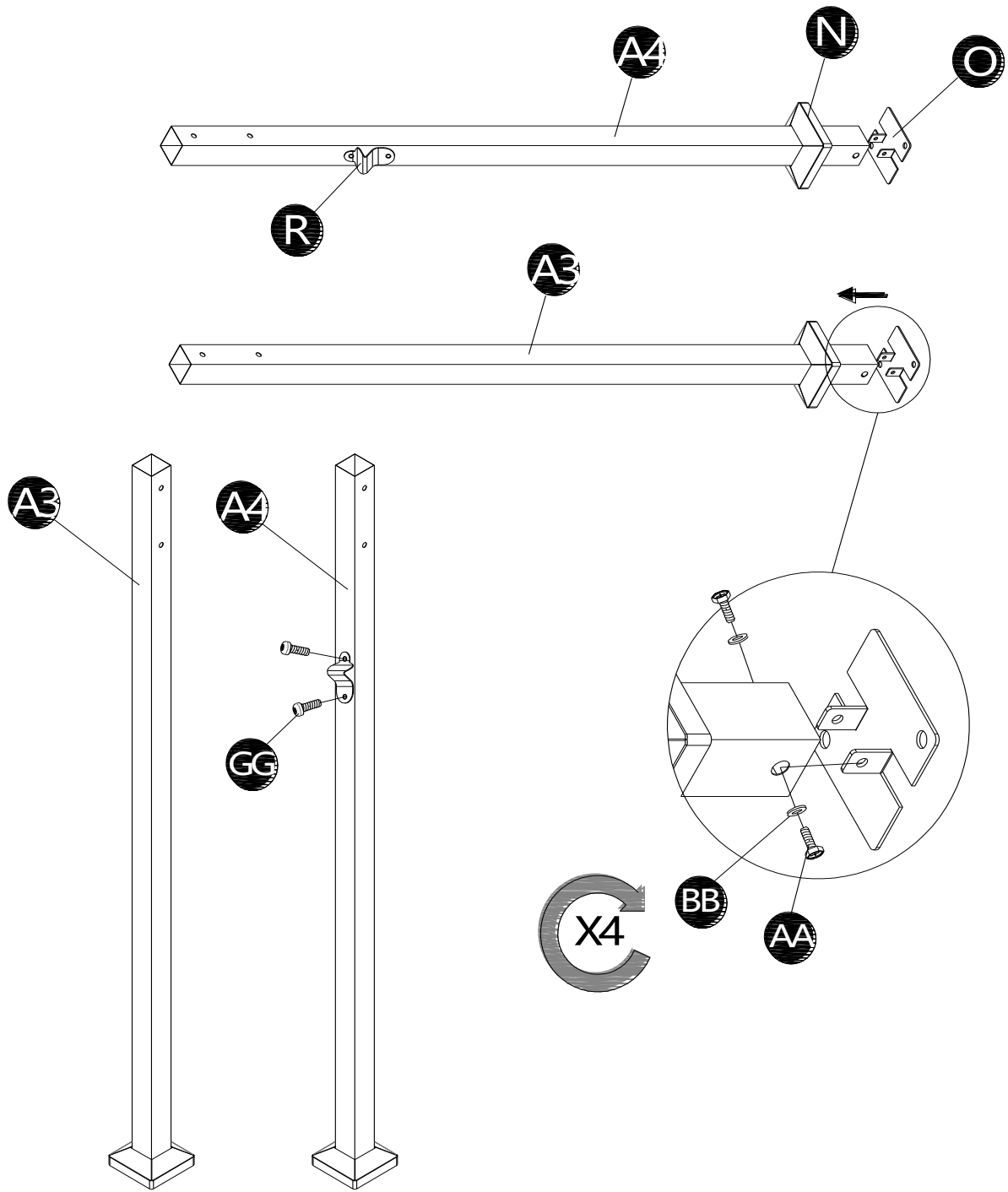

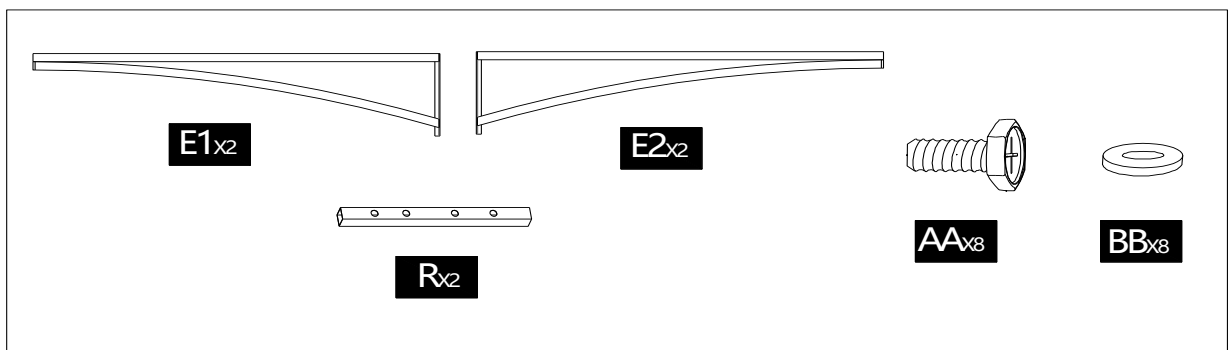
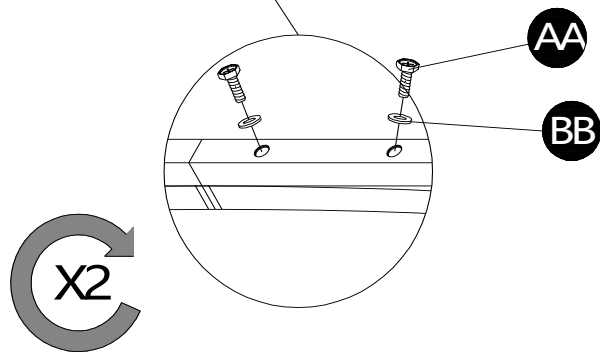
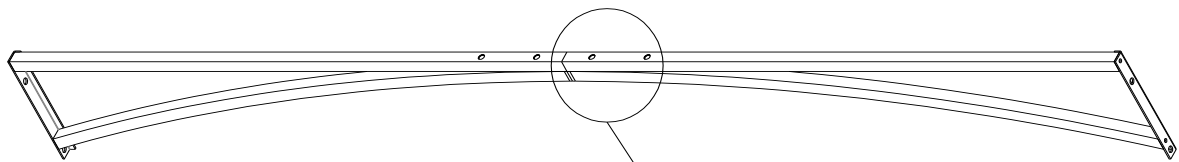
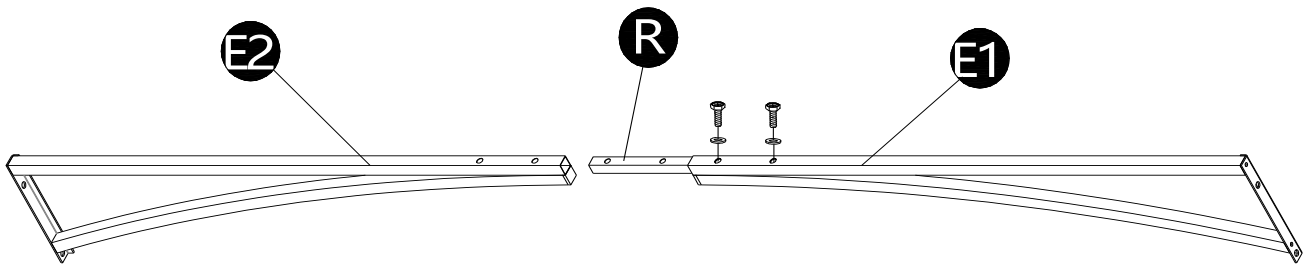

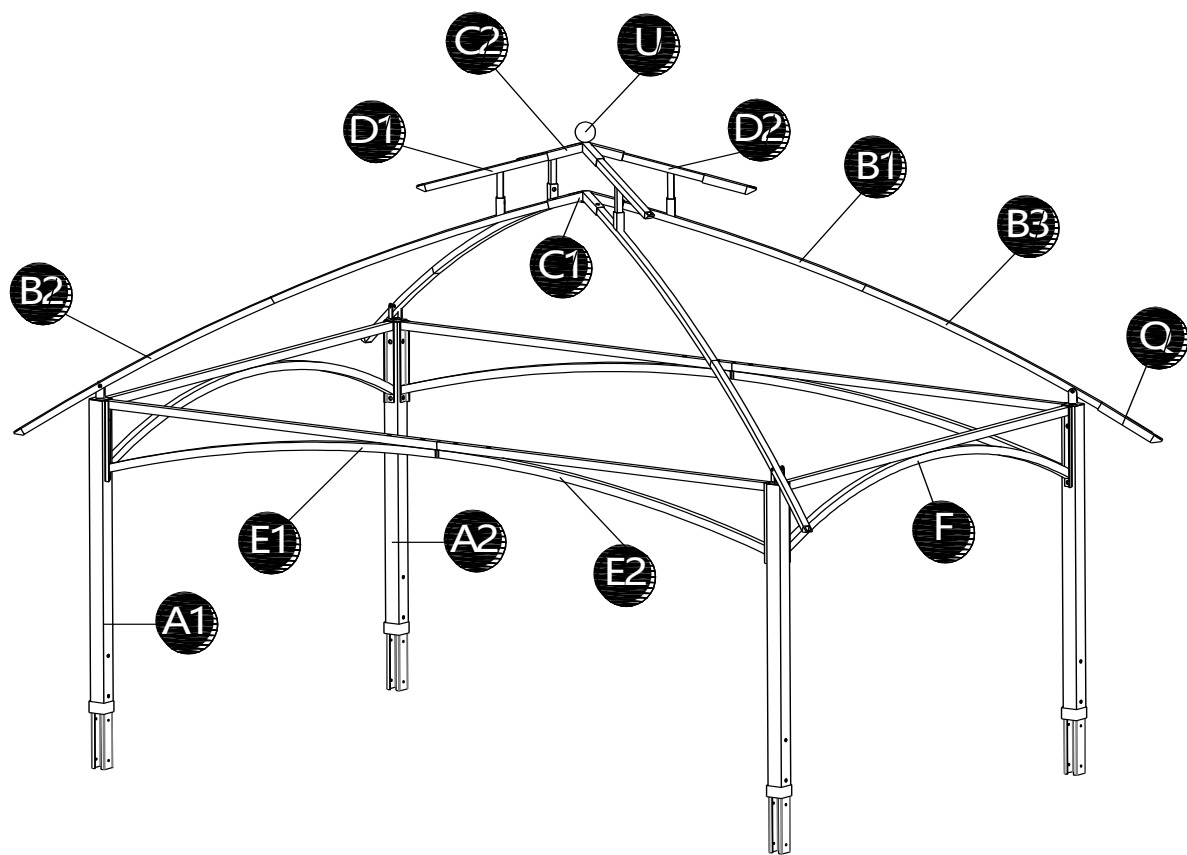

At the consideration of your safe, we designed the knock-down plan for our gazebo series, so that you will save the climbing part.

Please finish the gazebo installing on the ground first and then put up the bottom Post.

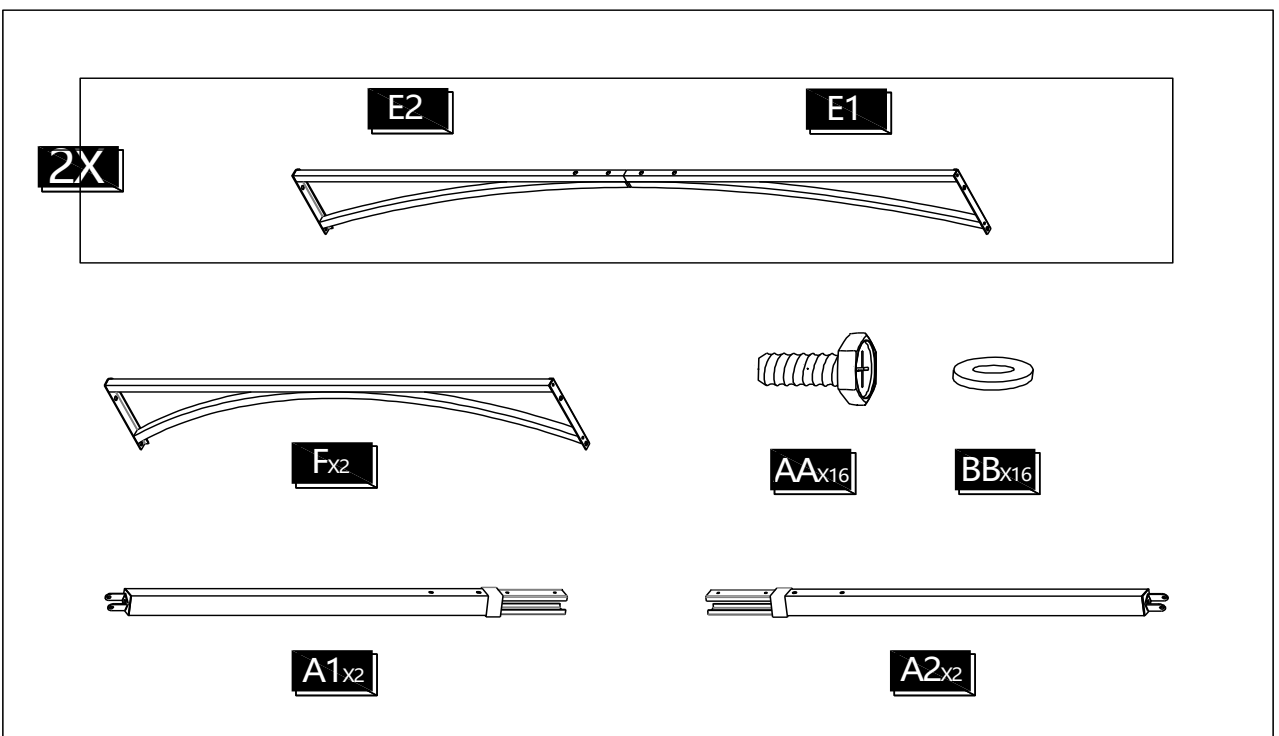
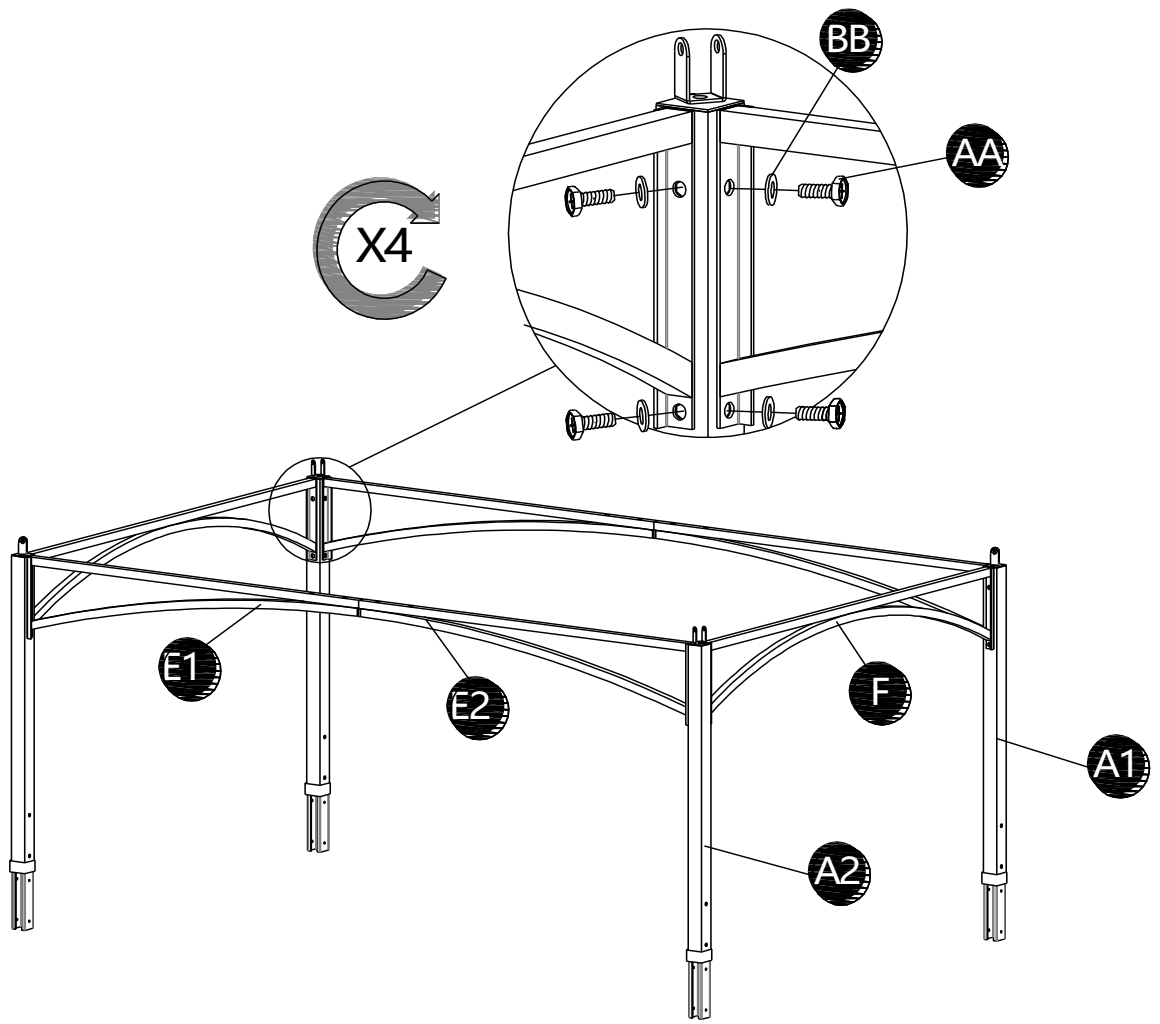



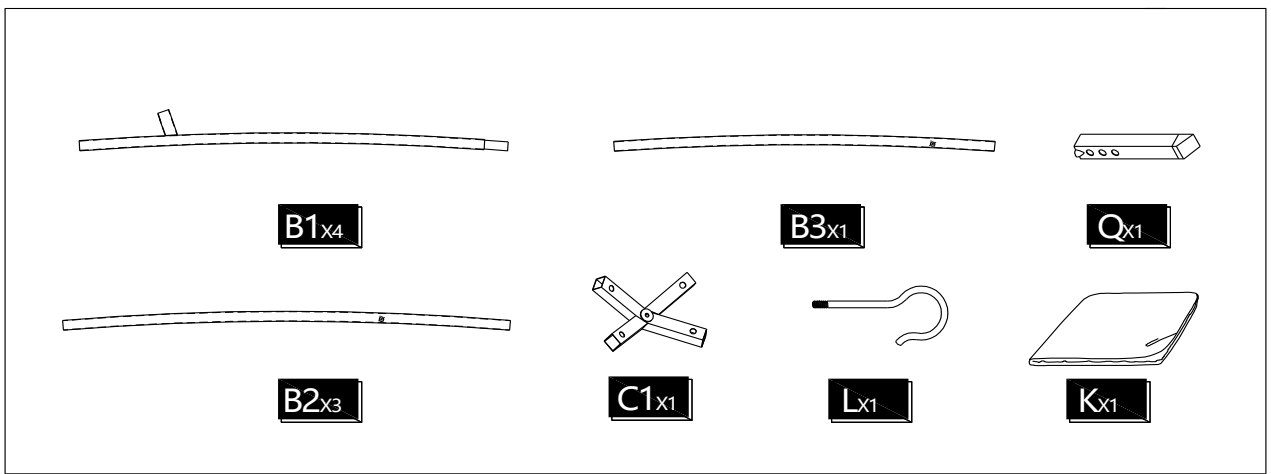
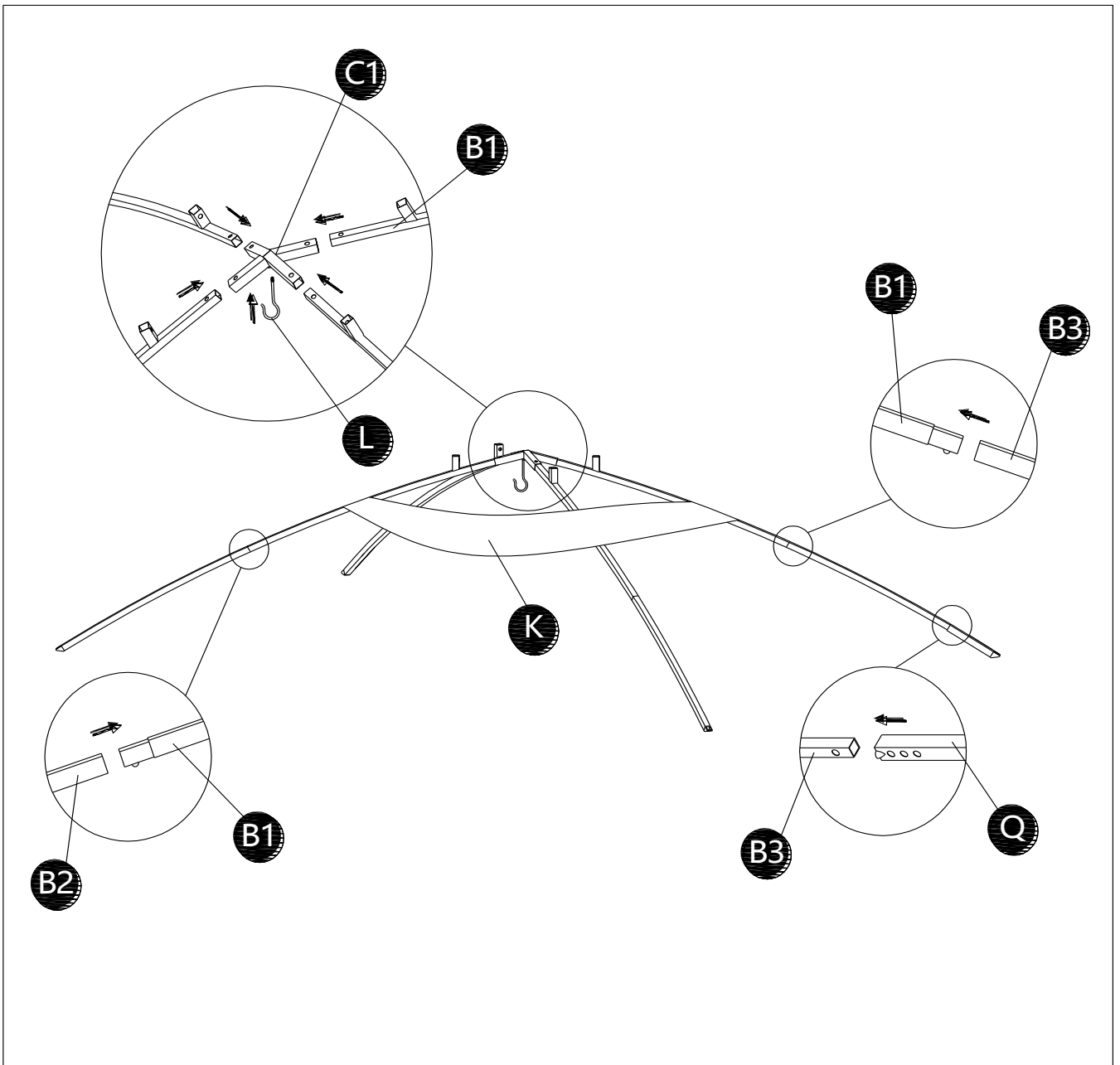

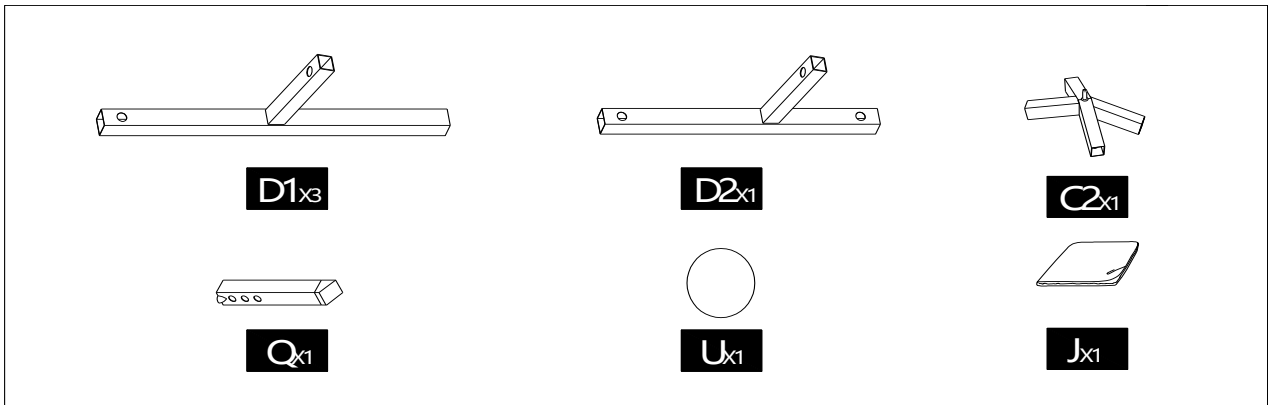
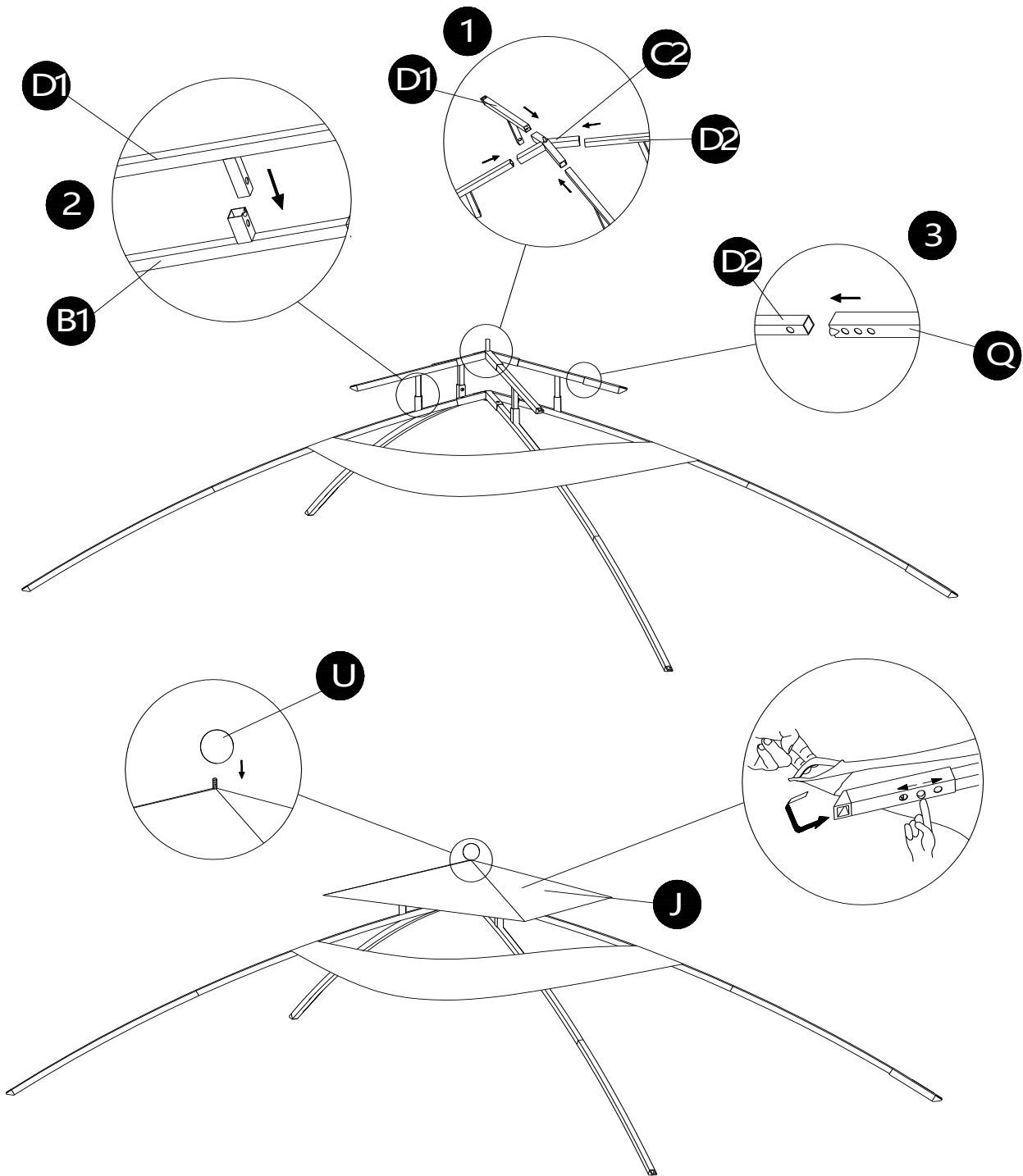

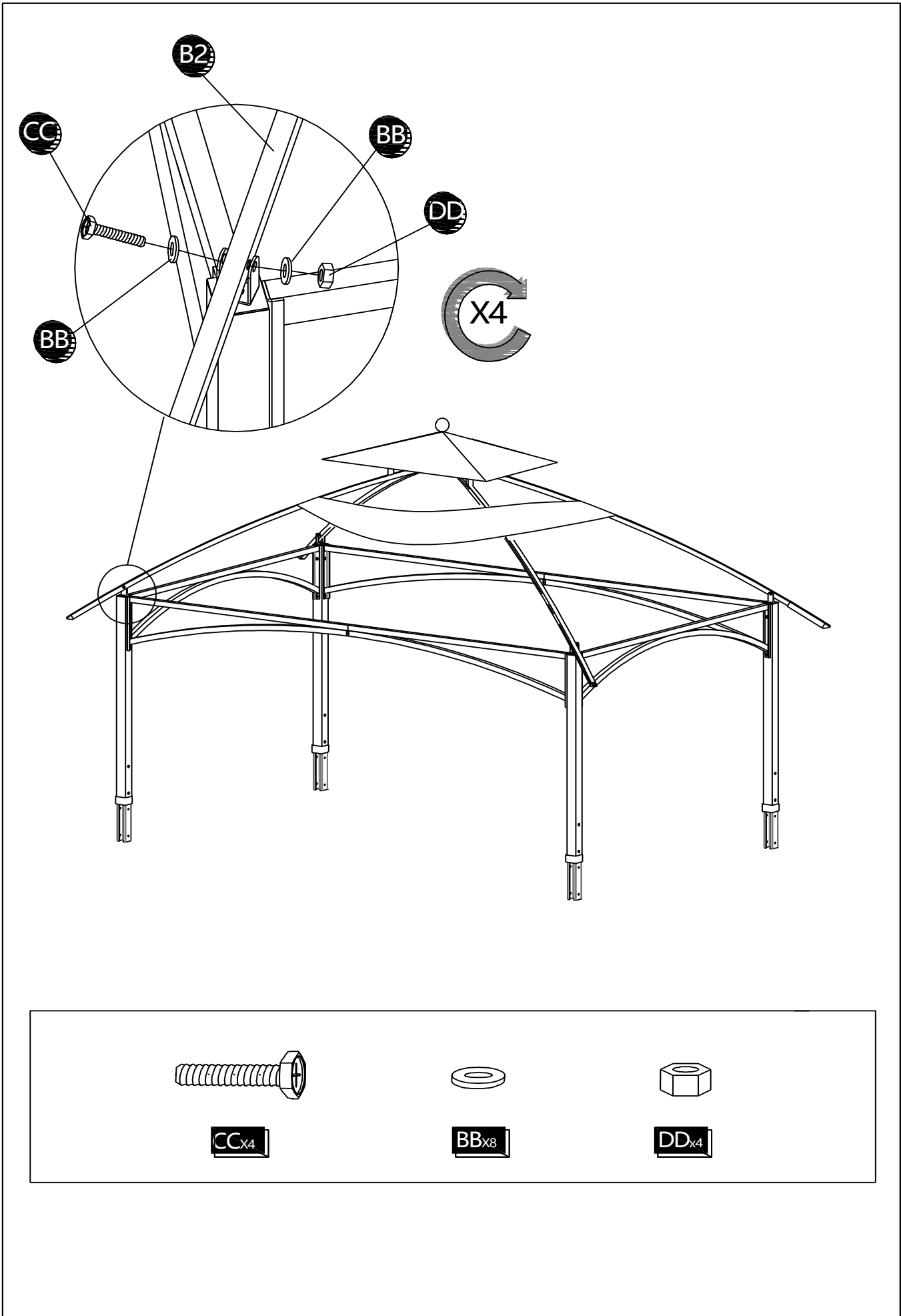

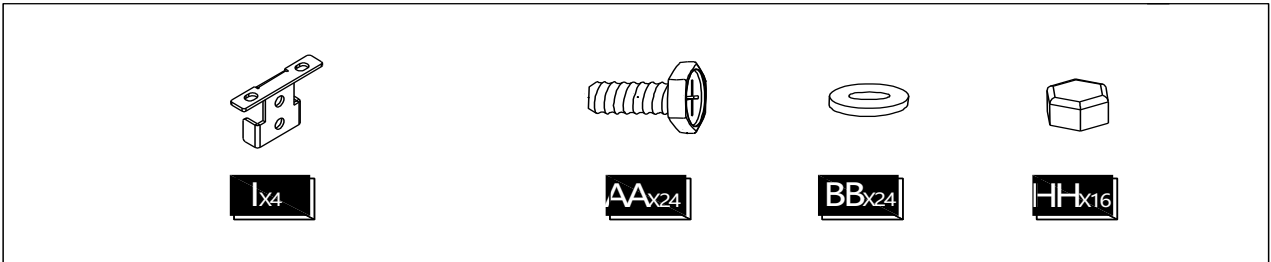
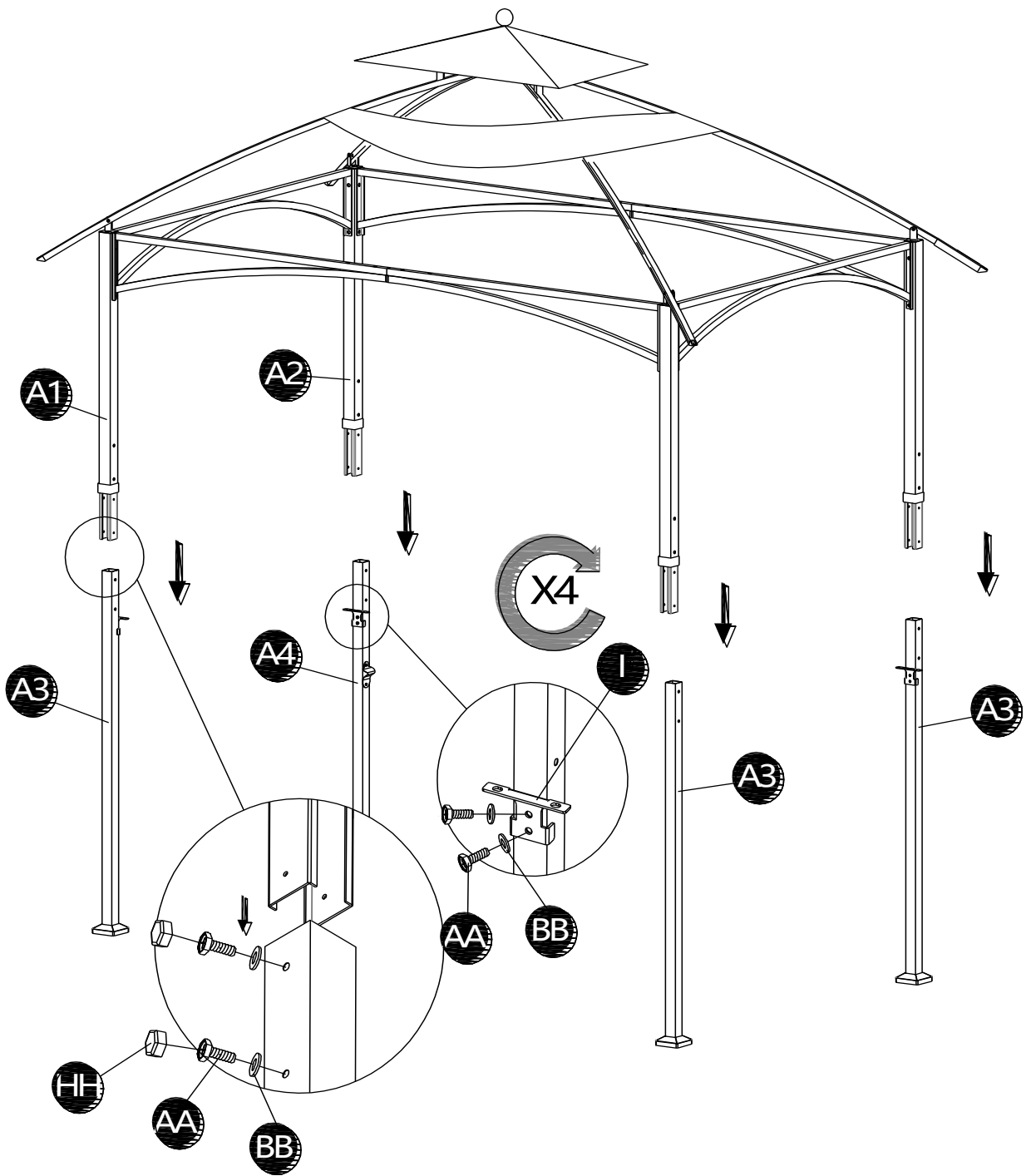

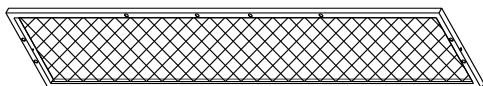
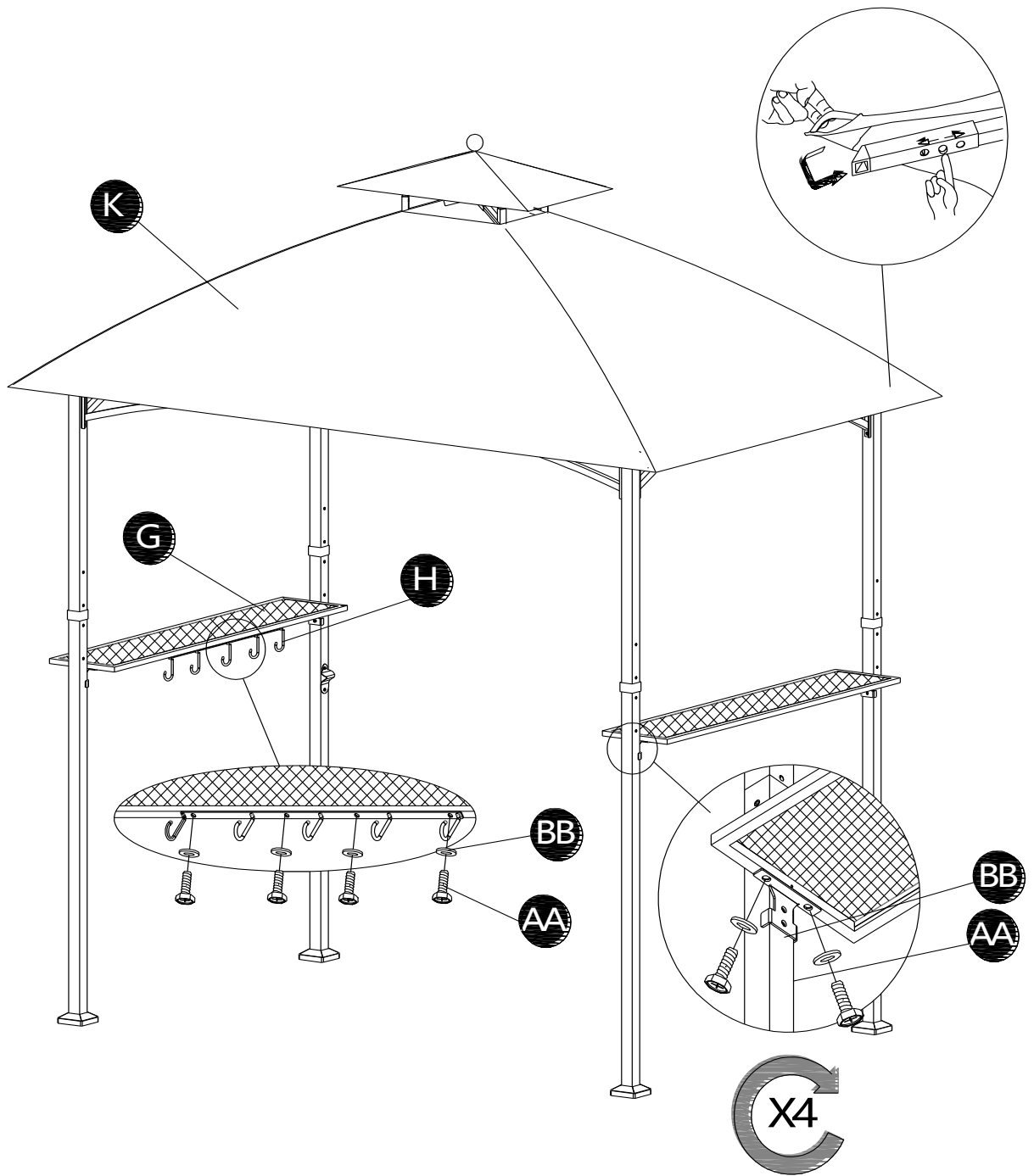

**Gx2**

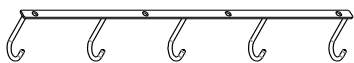

**Hx1**

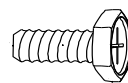

**AAx12**



**BBx12**

